

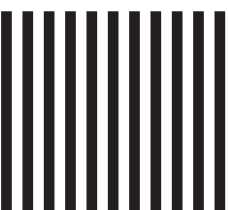

NO POSTAGE
NECESSARY
IF MAILED
IN THE
UNITED STATES



BUSINESS REPLY MAIL

FIRST CLASS PERMIT NO. 558 ST. CLOUD, MINNESOTA

POSTAGE WILL BE PAID BY ADDRESSEE

STEARNS INC

PO BOX 1498

ST. CLOUD, MN 56302-9743



STEARNS®

OWNER'S MANUAL FOR STEARNS® INFLATABLE KAYAKS

SPREE™ ONE (B521)

AND

SPREE™ TWO (B522)

También se incluye versión en español.

Inclut aussi une version française.

Enthält deutsche Textversion.

IMPORTANT!

BEFORE PROCEEDING

READ THIS MANUAL CAREFULLY

(CONTAINS IMPORTANT SAFETY INFORMATION,

AS WELL AS CARE AND MAINTENANCE)

**Spree™ One
(B521)**



**Spree™ Two
(B522)**

Stearns® Inc.

St. Cloud, Minnesota 56302 U.S.A.

Phone: (320) 252-1642 or 1-800-697-5801

Fax: (320) 252-4425

www.stearnsinc.com

Note: If your state requires this document for licensing your boat, please contact Stearns® Customer Service Department for completion, or more information.

**MANUFACTURER'S STATEMENT OF ORIGIN
FOR A VESSEL
SOLD IN THE STATE OF _____**

The undersigned manufacturer hereby certifies that the new boat described below, the property of said manufacturer, has been transferred this _____ day of _____, 20____ on Invoice # _____ to:

Owner's/Dealer's Name _____
Address _____
City, State, Zip _____

Model Name	Model Year	Manufacturer's Hull Identification #
<input type="checkbox"/> Spree™ One (B521)	_____	HIN # _____
<input type="checkbox"/> Spree™ Two (B522)	_____	HIN # _____

Type: Kayak Hull Material: _____
Length Overall: _____ Beam: _____
Built for: Pleasure Use

U.S. Coast Guard Capacity Plate Information (where applicable):

Maximum persons capacity in whole persons _____
Maximum weight capacity (persons & gear) _____

The manufacturer further certifies that this was the first transfer of such new boat and that all information given herein is true and accurate to the best of their knowledge

STEARNS®

1100 Stearns Drive • Sauk Rapids, MN 56379

Signature _____

FIRST ASSIGNMENT

FOR VALUE RECEIVED, in the amount of \$ _____,
the undersigned hereby transfers the Certificate of Origin and the boat described therein
to _____

Address _____

and certifies that the boat is new and has not been registered in this or any other state; Stearns® also warrants the title of said boat at time of delivery, subject only to the liens and encumbrances as set out below:

Amount of Lien	Date	To Whom Due	Address
_____	_____	_____	_____

Dates _____ 20____, at _____

By: _____

Transferrer (Firm name) Sign Here _____ Position _____

Before me personally appeared _____ who by me being duly sworn under oath says the statements set forth above are true and correct. Subscribed and sworn to me before this _____ day of _____ 20_____.

(SEAL) Notary Public Date commission expires _____

OWNER'S MANUAL FOR STEARNS® INFLATABLE KAYAK

TABLE OF CONTENTS

Declaration of Conformity	2
1. Introduction	3
2. Warranty	3
2.1 Modifications	3
3. Boating Safety	4
3.1 Boating Regulations	5
3.1.1 Boating Safety Labels	5
3.1.2 Registration	5
3.1.3 Education	5
3.2 Responsibilities of the Operator(s)	6
3.3 Restricted Areas	6
4. Specifications	7
4.1 Capacity	7
4.2 Features	8
5. Preparing Your Stearns® Inflatable Kayak	9
5.1 Quick Start to Inflating Your Boat	9
5.2 Knowing Your Valves	10
5.3 Make Sure Chambers Are Aligned	10
5.4 Over Inflation	11
6. Underway	12
6.1 Before You Start	12
6.2 Transporting, Carrying, and Towing	12
6.3 Care and Maintenance	13
6.4 Folding	13
7. Repairs	14
7.1 Repairing Small Punctures and Cuts	14
7.2 Repairing Pinholes	14
7.3 Seam Openings	15
8. Troubleshooting	15
9. Limited Warranty	16

Stearns® Warranty Registration

Declaration of Conformity

(according to ISO/IEC Guide 22 and EN 45014)

Manufacturer's Name: Stearns Inc.

Manufacturer's Address: P. O. Box 1498
St. Cloud, MN 56302

declares, that the product:

Product Name: Spree One™, Spree Two™
Model Number(s): B521, B522

to which this declaration relates, **meets the essential health and safety requirements** and is in conformity with the relevant EU Directives listed below:

General Product Safety Directive

using the relevant section of the following EU standards and other normative documents:

EN / ISO 6185-1 : 2002

ABYC H28-76

Date: 01/09/04

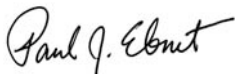

Paul Ebnet, President

This product complies with European directives for recreational vessels as published by the International Organization for Standardization (ISO).

1. INTRODUCTION

This manual has been compiled to help you operate your craft with safety and pleasure. It contains details of the craft, the equipment supplied or fitted, its systems, and information on its operation and maintenance. Please read it carefully, and familiarize yourself with the craft before using it.

If this is your first craft, or you are changing to a type of craft you are not familiar with, for your own comfort and safety, please ensure that you obtain handling and operating experience before assuming command of the craft.

PLEASE KEEP THIS MANUAL IN A SECURE PLACE, AND PASS IT ON TO THE NEW OWNER IF YOU SELL THE CRAFT.

2. WARRANTY

Complete and return the Warranty Registration Form found on the back page of this Owner's Manual.

2.1 MODIFICATIONS

Because of the possibility of interference with the factory design integrity of the kayak, owner modifications to the kayak are not recommended.

Unauthorized modifications to the kayak could compromise safety, design integrity or warranty coverage.

3. BOATING SAFETY



This is the safety alert symbol. It is used to alert you to potential personal injury hazards. Obey all safety messages that follow this symbol to avoid possible injury or death.

DANGER

Indicates an imminently hazardous situation which, if not avoided, will result in death or serious injury or substantial property damage.

WARNING

Indicates a potentially hazardous situation which, if not avoided, could result in death or serious injury or property damage.

CAUTION

Indicates a potentially hazardous situation which, if not avoided, may result in property damage.

CAUTION

Used without the safety alert symbol indicates a potentially hazardous situation which, if not avoided, may result in property damage.

NOTICE

Indicates installation, operation or maintenance information which is important but not hazard-related.

The precautions listed in this manual and on the craft are not all-inclusive. If a procedure, method, tool or part is not specifically recommended, you must satisfy yourself that it is safe for you and others, and that the craft will not be damaged or made unsafe as a result of your decision. REMEMBER - always use common sense when paddling YOUR KAYAK!

3.1 Boating Regulations

The U.S. Coast Guard is the authority of the waterways; they are there to help the boating public. State boating regulations are enforced by local authorities. You are subject to marine traffic laws and “Rules of the Road” for both federal and state waterways; you must stop if signaled to do so by enforcement officers.

There are many pamphlets, prepared by the Coast Guard, available to you. These pamphlets explain “Rules of the Road,” signal lights, buoys, safety equipment, international and inland regulations and much more than is presented in this manual. For more information contact your local U.S. Coast Guard Unit or call the Coast Guard Customer Info line at 1-800-368-5647.

3.1.1 Boat Safety Labels

Your kayak is affixed with various safety labels at the time of manufacture. These labels appear at specific locations on the craft where safety is of particular concern. Safety labels must remain legible and should not be removed. If you suspect a label is missing or one becomes damaged, contact STEARNS® at 320-252-1642 or 1-800-697-5801.

3.1.2 Registration

The U.S. Coast Guard requires that all power boats operated on the navigable waters of the United States must be registered in the state of main use; also, many States require registration in that state whenever boating on waters within their state boundary. Always contact your state boating authorities (and neighboring states) for registration information on boats.

Once you have been issued a number, it is best to affix it on the boat by printing it on the material with a permanent ink marker.

3.1.3 Education

This manual is not intended to provide complete training on all aspects of boat operation. We strongly recommend that all operators of this boat seek additional training on boat handling and safety, and provide safety training for all passengers.

3.2 RESPONSIBILITIES OF THE OPERATOR(S)

IMPORTANT

Users of this product agree by their use to accept the inherent risks involved in this water sports activity and agree to follow all instructions, DANGERS, CAUTIONS, and WARNINGS carefully before using their STEARNS® kayaks.

- **READ OWNER'S MANUAL: Improper Use May Cause Injury or Death.** Pay close attention to items marked "DANGER," "WARNING," "CAUTION" or "NEVER."
- Use the kayak in a **SAFE** and **SOBER** manner, taking all reasonable precautions.
- Each passenger **MUST** Wear an approved personal flotation device (PFD). All safety equipment & PFDs must be in good condition and suitable for your kayak and passenger use.
- **THIS KAYAK IS NOT A PERSONAL FLOTATION DEVICE.**
- Follow all inflation and care instructions.
- **BE AWARE** of local boating regulations and follow them.
- **BE AWARE** of your environment, water currents, tides, weather, traffic and other potential hazards in the water and surroundings.
- **DO NOT** use this kayak **UNDER** the **INFLUENCE** of **DRUGS** or **ALCOHOL**.
- **DO NOT** use this kayak if you suspect a tear or hole. **IT MAY BE UNSAFE.**
- **USE CAUTION** when entering or exiting the kayak. Keep your weight centered and distribute the weight of the gear and passengers evenly.
- **DO NOT** allow children to use this kayak without the supervision of an adult or someone who is experienced in its safe use.
- **DO NOT** tow this kayak.
- **Seek shelter** from open water if there is threat of lightning.

3.3 RESTRICTED AREAS

Before kayaking, check with Local, State and Federal authorities to identify restricted areas. Because of the threat of terrorism, the U.S. Coast Guard has and will continue to implement strict limits on watercraft near U.S. Navy and Coast Guard ships and other potential targets.

4. SPECIFICATIONS

	Spree™ One (B521)	Spree™ Two (B522)
Dimensions:	Length - 9' 6" (289 cm) Beam - 32" (81 cm)	Length - 11' 7" (353 cm) Beam - 35" (89 cm)
Dry Weight:	23 lbs (10 kg)	31 lbs (14 kg)
Max. Persons Capacity:	1 person	2 persons
Max. Persons & Gear Capacity:	250 lbs NMMA 105 kg (231 lbs) ISO	400 lbs NMMA 150 kg (330 lbs) ISO
Recommended Pressure:		
Main Chambers:	1.75 psi (0.12 bar)	1.75 psi (0.12 bar)
Floor Chamber:	1.0 psi (0.07 bar)	1.0 psi (0.07 bar)

4.1 CAPACITY

The person/load capacity is determined by the availability of proper seating on the kayak. Acceptable seating determines the number of passengers, not the overall load capacity.

Spree™ One



NMMA/ISO

Spree™ Two

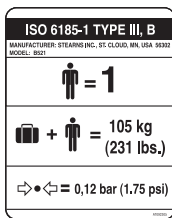

ISO



NMMA/ISO

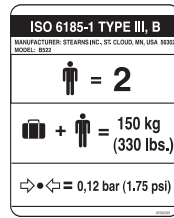

ISO

WARNING

Do not exceed the certified maximum capacities under any circumstances. Overloading will reduce freeboard and increase the likelihood of swamping, especially in heavy seas. Overloading causes handling to become sluggish, making it difficult to react quickly.

4.2 FEATURES

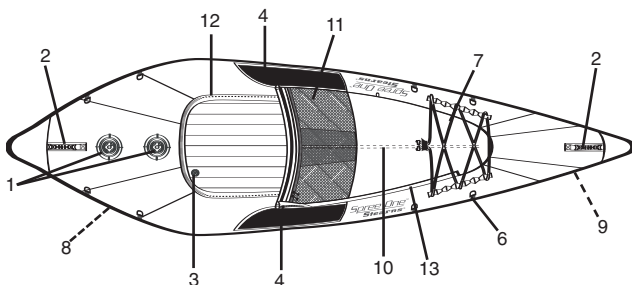

Spree™ One

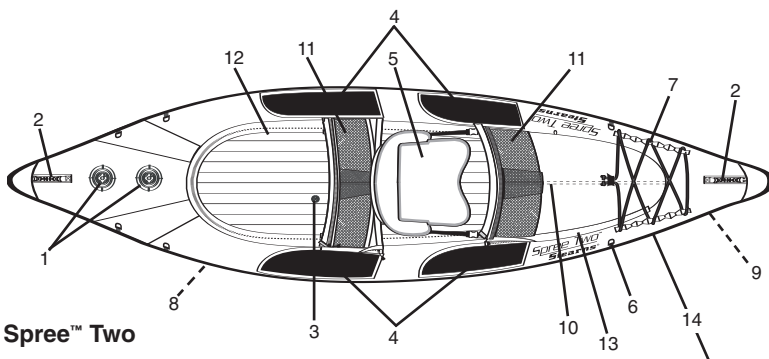

Spree™ Two

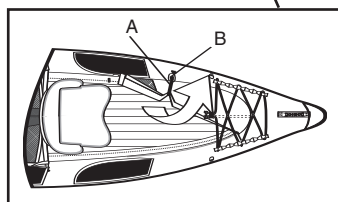

1. Main chambers (2) valves
2. Carrying / grab handles
3. Floor valve
4. Knuckle abrasion guards
5. Seat (B522 only)
6. Tie down D-rings
7. Tie down cords
8. Tracking fin(s)
9. Abrasion rail guards
10. Spray skirt tensioner
11. Mesh pocket
12. Chamber access zippers
13. Spray deck zipper

14. Rolling up spray deck

To roll back and secure spray deck on hot days

1. Roll tightly the spray deck
2. Pull elastic strap (A) from under spray deck
3. Loop through hoop (B) to secure

5. PREPARING YOUR STEARNS® INFLATABLE KAYAK

The STEARNS® Inflatable Kayak is designed for recreational use and can be used in a number of settings. Every usage has its own set of required skill levels and dangers. Be sure you are prepared for each use before attempting it and you understand the inherent dangers.

Inflation Setup

Use a STEARNS® “bellows” style foot pump (Model B502) or equivalent pump to inflate your boat. Use caution not to over inflate your boat. (Pump not included)

For proper inflation and safety, the user must make sure that the wall inflation valves are sealed properly.

WARNING

NEVER USE COMPRESSORS, CO₂ OR COMPRESSED AIR. DO NOT OVER-INFLATE THE FLOOR OR THE SIDE CHAMBERS.

5.1 QUICK START TO INFLATING YOUR KAYAK

Follow the steps listed below. Damage to chambers can occur if these steps are not followed. For more information on inflation see page 11.

1. Unfold and lay out kayak on flat, level ground
2. Floor should be positioned inside Hull
3. Inflate floor until firm

DO NOT OVER INFLATE FLOOR CHAMBER beyond 1.0 psi (0.07 bar)

4. Partially inflate the **inner** chamber (main chamber closest to the seating area). Refer to page 10 for valve operation.
5. Partially inflate the **outer** chamber, until the cover shape begins to fill out. The kayak should feel soft or limp at this point.
6. Make sure the 2 air valves are aligned with the cover. Adjust cover if necessary.
7. Next add air to each chamber until most of the wrinkles are gone and the kayak feels firm to the touch.

DO NOT OVER INFLATE MAIN CHAMBERS beyond 1.75 psi (0.12 bar)

8. Make sure all air valves are closed and screwed down tightly.

(See figure on next page)

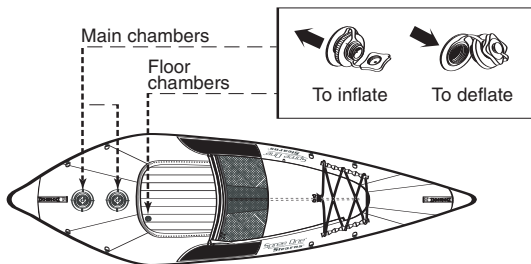

5.2 KNOWING YOUR VALVES

Stearns Kayaks use two types of valves. Type I (Type II, is a smaller version) to inflate floor and main chambers.

Type I (II)

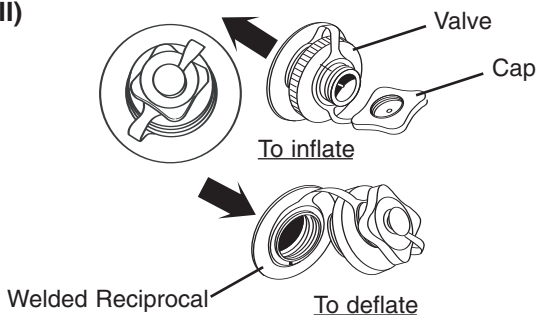

5.3 MAKE SURE CHAMBERS ARE ALIGNED:

- Internal air chamber is aligned in relation to the cover which can be adjusted by unzipping the access zippers
If the air chambers are not aligned or centered:
 - Relieve air pressure
 - Unzip the cover
 - Partially inflate
 - Realign air chambers, zip cover and inflate chambers
- All valves are closed tightly

5.4 OVER INFLATION

CAUTION

Do not over-inflate the kayak. Over-inflation is the primary cause of leaks. Inflate the kayak until most of the wrinkles in the fabric are gone and it feels firm to the touch, but do not exceed 1.75 psi (0.12 bar) in the main air chambers and 1.0 psi (0.07 bar) in the floor chamber.

Water temperature and weather affect the air pressure in the boat. In cold weather your kayak will lose some pressure because the air will contract. If this occurs, you may want to add more air to improve your boat's performance. In hot weather, the air will expand. You must let out some air to prevent the boat from failing from over pressure. Avoid exposing your kayak to extreme temperatures (hot or cold).

CAUTION

On warm sunny days, keep the kayak either in water or in shade (if kept inflated on land). This will avoid expanding chambers due to rise in temperature which can result in seam tears, delamination, popped I-Beams and pinholes. Also keep in mind to avoid asphalt, sand, pebbles or concrete in direct sunlight as they radiate high ground heat.

Check for proper inflation often. Use your thumb to press on the port (left) and starboard (right) air chambers. You should be able to press down 3/4 in. (19 mm). The chamber should feel firm without too much resistance.

If you have difficulty achieving 3/4 in. (19 mm), the chamber could be over inflated.

If you are easily able to press further than 3/4 in. (19 mm), the chamber could be under inflated.

Before paddling, be sure all the kayak's air chambers are properly inflated.



DO NOT overload your kayak which exceeds the rating on the capacity plate. Overloading a kayak can result in loss of control and an unsafe kayak. If your kayak has no capacity plate, contact the selling dealer or the manufacturer.

6. UNDERWAY

In all your uses of STEARNS® Inflatable Kayaks, make SAFETY a high priority. Each person should wear an approved personal flotation device. Learn about your boating area. Get official information about the local conditions, tides and currents before kayaking there. Be careful that you do not overestimate your strength, endurance or skill. Be careful never to underestimate the forces of nature.

6.1 Before You Start

Be smart when boating and using your equipment.

- Properly inflate your kayak. Do not under or over inflate. Outside temperatures of air and water will drastically change the volume inside chambers. Chambers may need to be adjusted (inflated or deflated) for optimum performance and safety.
- Know the conditions of the environment.
- Tell someone of your travel plans. Check local weather reports before casting off; do not leave the dock area when strong winds and electrical storms are in the area or predicted to be in the area.
- Secure or store loose items before getting underway.

6.2 Transporting, Carrying and Towing

Your kayak should always be transported dry and in its transporting (carrying) bag. Dry and clean as much as possible before placing boat in carrying bag. Once you have reached your destination, or before long periods of non-use, inflate the kayak and allow it to air dry before storing.

Use care when transporting or storing to avoid sharp points or edges; they will damage your kayak. Use the carrying handles to lift your kayak. Never pull or lift it by the sides or attach any other device to lift or carry it.

WARNING

Do not exceed the maximum recommended load. The total weight of all persons, gear and fluid capacities must never exceed the maximum load.

6.3 Care and Maintenance

The STEARNS® inflatable kayak is made of very durable materials. However, like anything else, proper care will increase the life of your kayak. Before storing your kayak, make sure it is clean and completely dry before you store it in its carrying bag. It should be deflated and kept out of direct sunlight when stored. Avoid exposure to extreme temperatures (hot or cold). If your kayak is exposed to freezing temperatures while storing, allow it to warm before unfolding. If a zipper is stuck or sticking, do not force it. Use liquid soap and a toothbrush to lubricate the zipper open. Rinse completely.

Never unzip the chamber covers when the kayak is inflated.

Be sure to rinse your kayak with fresh water after every use in salt water and allow it to dry thoroughly before storing.

To store your boat:

1. Drain excess water through the floor drain plug.
2. Wash your kayak using a mild soap or detergent. Never use strong solvents to clean your kayak. Rinse it off with fresh water and allow it to dry thoroughly before storing.
3. Deflate the kayak. Make sure the valves are open so air can flow freely. Dry and clean as much as possible before placing kayak in carrying bag.
4. Fix any punctures before storing your kayak in the carrying bag.

6.4 FOLDING

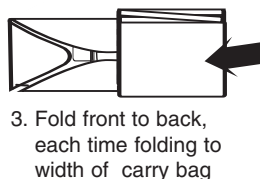
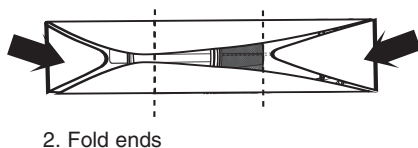
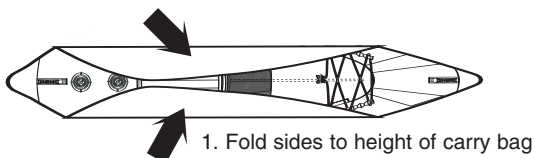

7. REPAIRS

The STEARNS® Spree One™ and Spree Two™ come equipped with a repair kit that includes adhesive and several patches. This can be found in the mesh pocket and should remain with the boat. Making repairs to the inner tube of the boat may require unzipping the cover and temporarily removing the tube. Always make sure the boat is fully deflated before unzipping the cover. If there is difficulty opening the zipper, refer to the section “**Care and Maintenance.**” When the repair has been completed, be sure the tube is aligned properly in the boat cover and the zipper is completely closed and appropriately locked.

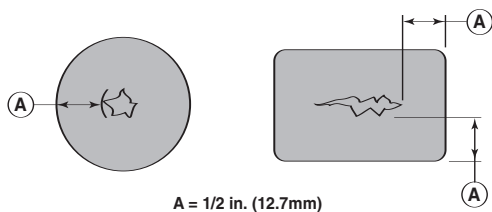

Figure 9

7.1 Repairing Small Punctures and Cuts

1. Cut a patch which is round or with round corners, at least 1/2 in. (12.7 mm) larger than the hole or cut.
2. Use water and/or mild soap to clean the area where the patch will be placed.
3. Make sure all surfaces are dry.
4. Spread a thin layer of glue on both the patch and on the damaged area and let it sit for three to five minutes or until tacky.
5. Press the patch onto the boat, making sure that no air bubbles form.
6. Apply pressure to the patch by placing weight on it. Do not peel back to see if adhesive is holding.
7. Do not inflate the boat for at least twelve hours.

7.2 Repairing Pinholes

1. Inflate the kayak. Locate the pinhole by sponging soapy water over the tube until you see air bubbles.
2. Deflate the kayak. Clean the area around the pinhole and apply a drop of adhesive to the hole once the area is completely dry. A patch may not be necessary.

7.3 Seam Openings

Seam openings are difficult to repair but can be done with certain seam repair adhesives. Contact STEARNS® for more information or ask your local marine shop.

8. TROUBLESHOOTING

This chart will help you find and correct minor problems with your kayak.

Problem	Solution
Slow leak.	Check valve gaskets and make sure the cap tether is not interfering with the seal. The valve gaskets must be closed tightly.
Still leaks slowly.	Check for pinholes. Read section “Repairing Pinholes.”
Doesn't inflate completely.	Make sure that the tube is aligned.
The zipper is stuck.	Read “Care and Maintenance” section (6.3) regarding zippers.
Difficulty draining water.	Wipe off excess water with a high absorbing sponge or towel. The kayak dries much quicker inflated, and in a well ventilated area. Do not expose in direct sunlight to dry. Deflate kayak and briefly hang it from the molded handles with seat(s) removed and seating compartment exposed. To avoid mold, do not pack or fold while boat is damp or wet.

9. LIMITED WARRANTY

STEARNS® warrants this product to be free from defects in material or workmanship for a period of one year from the date of purchase.

Products that prove to be defective under conditions of normal and proper use during the warranty period because of defective workmanship or faulty material will be replaced or repaired without charge. For warranty service, return product to place of purchase.

STEARNS® shall inspect all warranty claims and in the event of a defect, repair or replace the defective part or entire item, at its option.

This warranty does NOT cover:

Products used for rental, for hire or in professionally guided tours and other uses not considered normal recreational purposes; punctures, cuts and abrasions sustained in normal use; items involved in accidents; items damaged in whitewater mishaps, and other unreasonable uses or improper storage.

STEARNS® shall within (30) days from receipt of an authorized return from purchaser, perform its responsibilities in conformance with this warranty.

THERE ARE NO WARRANTIES WHICH EXTEND BEYOND THE DESCRIPTION OF THE FACE HEREOF. STEARNS SHALL NOT BE HELD LIABLE FOR INCIDENTAL AND CONSEQUENTIAL DAMAGES.

THIS WARRANTY IS INCLUSIVE IN LIEU OF ALL OTHER WARRANTIES.

This warranty gives you specific legal rights and you may also have other rights that vary from state to state.

Stearns® Inc.
1100 Stearns Drive
Sauk Rapids, MN 56379
USA
320-252-1642
www.stearnsinc.com

STEARNS® WARRANTY REGISTRATION

(PLEASE TYPE OR PRINT CLEARLY)

Please complete and mail this card to Stearns within 10 days. It will register your product in case you ever lose your proof of purchase information.

Owner's Name _____

Address _____

City _____ State _____ Zip _____ Country _____

Model # Spree™ One (B521) Spree™ Two (B522)

H.I.N. # _____

Purchase Date _____

Dealer's Name _____

Address _____

City _____ State _____ Zip _____ Country _____

Thank you for responding to the following:

1. How did you first learn of this product?

_____ Dealer _____ Friend _____ Magazine _____ Radio
_____ TV _____ Catalog _____ Internet _____ Other

2. What most influenced your decision to purchase this product?

_____ Price _____ Features _____ Stearns' reputation
_____ Quality _____ Other

3. Do you own other Stearns products?

_____ Yes _____ No

If yes,

_____ Watersports Products

_____ Stearns Outdoors® Products

_____ Mad Dog Gear® Products