



ULTRA-LITE™ EXPEDITION INFLATABLE KAYAK

OWNER'S MANUAL
MODEL AE1009

PATENTED



1 PERSON KAYAK



IMPORTANT!

PLEASE READ THIS MANUAL CAREFULLY BEFORE PROCEEDING. AFTER READING THIS MANUAL, SAVE THESE INSTRUCTIONS FOR FUTURE REFERENCE.



INFLATABLE KAYAKS WITH CUTTING
EDGE TECHNOLOGY

INTRODUCTION

It is our goal, at Advanced Elements, to develop new and unique paddlesports products that enhance our customers' outdoor experience. Our focus is on designing and manufacturing "Inflatable kayaks with cutting edge technology". Our kayaks incorporate many different materials and components and deliver high performance at a very reasonable price. We are the makers of the AdvancedFrame™ Inflatable kayaks, DragonFly™ Inflatable kayaks and StraitEdge™ Canoe and Kayaks. The AdvancedFrame™ Kayaks are a hybrid of a folding frame kayak and an inflatable kayak. Its bow slices through water like a knife and rivals the tracking of hard-shell kayaks. The stern acts as a skeg increasing the tracking performance. The DragonFly™ kayaks are durable and lightweight. They have built-in rigid forms that increase the performance once it is fully inflated. You can take our inflatables with you anywhere in the world and no roof rack is needed! Keep it in the trunk of your car and paddle whenever you want or pack it into a remote wilderness area and paddle where no one has paddled before. Simply inflate with a foot pump and hit the water in minutes. Please visit our website for more information on our products or to find a dealer near you.



TABLE OF CONTENTS

1. Caution/Safety	4
1.1 Boating Safety.....	5
2. Specification.....	6
2.1 Capacity	6
2.2 Features	6
3. Assembly/Inflating/Deflation Instruction	7
3.1 Assembly	7
3.2 Understanding Your Valves.....	8
3.3 Inflating.....	9
3.4 Over Inflation.....	10
3.5 Deflation.....	10
3.6 Folding	10
4. Guidelines for Usage	11
5. Proper Care and Storage	11
6. Repairs.....	12
6.1 Repairing Small Punctures and Cuts.....	12
6.2 Repairing Pinholes	12
7. Troubleshooting.....	13
8. Statement of Origin	17
9. Declaration of Conformity	18
10. Warranty and Registration.....	19

1. CAUTION - SAFETY WARNING

Users of this product agree by their use to accept the inherent risks involved in this paddlesports activity and agree to follow all instructions, cautions, and warnings carefully before using this Kayak.

(PLEASE READ CAUTION STATEMENT CAREFULLY)

CAUTION

SAFETY WARNING

PADDLESPTS CAN BE VERY DANGEROUS AND PHYSICALLY DEMANDING. THE USER OF THIS PRODUCT SHOULD UNDERSTAND THAT PARTICIPATION IN PADDLESPTS MAY INVOLVE SERIOUS INJURY OR DEATH. OBSERVE THE FOLLOWING SAFETY STANDARDS WHENEVER USING THIS PRODUCT.

- GET PADDLESPTS INSTRUCTIONS SPECIFIC TO THIS TYPE OF CRAFT.
- OBTAIN CERTIFIED FIRST AID TRAINING AND CARRY FIRST AID AND RESCUE/SAFETY EQUIPMENT.
- ALWAYS WEAR A NATIONALLY APPROVED PERSONAL FLOTATION DEVICE.
- ALWAYS WEAR A HELMET WHERE APPROPRIATE.
- DRESS APPROPRIATELY FOR WEATHER CONDITIONS; COLD WATER AND/OR COLD WEATHER CAN RESULT IN HYPOTHERMIA. CHECK YOUR EQUIPMENT PRIOR TO EACH USE FOR SIGNS OF WEAR OR FAILURE.
- NEVER PADDLE ALONE.
- DO NOT PADDLE IN FLOOD CONDITIONS.
- BE AWARE OF APPROPRIATE RIVER WATER LEVELS, TIDAL CHANGES, DANGEROUS CURRENTS, WEATHER CHANGES, AND STRONG OFF SHORE WINDS.
- SCOUT UNFAMILIAR WATER; PORTAGE WHERE APPROPRIATE.
- DO NOT EXCEED YOUR PADDLING ABILITY; BE HONEST WITH YOURSELF.
- CONSULT YOUR PHYSICIAN PRIOR TO BEGINNING YOUR PADDLESPTS TRAINING.
- YOU MUST NOT USE ALCOHOL OR MIND ALTERING DRUGS PRIOR TO USING THIS PRODUCT.
- FOLLOW THE MANUFACTURER'S RECOMMENDATIONS FOR THE USE OF THIS PRODUCT.
- IF ADDITIONAL OUTFITTING IS REQUIRED, USE MANUFACTURER'S APPROVED MATERIALS ONLY; DO NOT IMPAIR ENTRY OR EXIT ACCESS.
- READ OWNER'S INFORMATION PACKET PRIOR TO USING THIS PRODUCT.

THE USER OF THIS PRODUCT ACKNOWLEDGES BOTH AN UNDERSTANDING AND AN ASSUMPTION OF THE RISK INVOLVED IN PADDLESPTS.

ADVANCED ELEMENTS, INC.

TOLL FREE 866-262-9076

Please read this entire manual for additional safety information. Please pay close attention to items marked **DANGER, WARNING, CAUTION, IMPORTANT, NOTICE, NEVER, and ALWAYS.**

1.1 Boating Safety



This is the safety alert symbol. It is used to alert you to potential personal injury hazards. Obey all safety messages that follow this symbol to avoid possible injury or death.

<p>! DANGER !</p>	<p>Indicates an imminently hazardous situation which, if not avoided, will result in death or serious injury or substantial property damage.</p>
<p>! WARNING</p>	<p>Indicates a potentially hazardous situation which, if not avoided, could result in death or serious injury or property damage.</p>
<p>! CAUTION</p>	<p>Indicates a potentially hazardous situation which, if not avoided, may result in property damage.</p>
<p>CAUTION</p>	<p>Used without the safety alert symbol indicates a potentially hazardous situation, which, if not avoided, may result in property damage.</p>
<p>NOTICE</p>	<p>Indicates installation, operation or maintenance information which is important but not hazard-related.</p>

The precautions listed in this manual and on the craft are not all-inclusive. If a procedure, method, tool or part is not specifically recommended, you must satisfy yourself that it is safe for you and others, and that the craft will not be damaged or made unsafe as a result of your decision. REMEMBER - always use common sense when paddling YOUR KAYAK!

2. SPECIFICATION

Dimensions:

Length:	13'
Width:	34"
Weight:	38 lbs (17 kg)
Max. Person Capacity:	400 lbs (181 kg)
Max. Persons & Gear Capacity:	450 lbs (204 kg)
Recommended Pressure:	
Main chambers:	2.0 psi (0.14 bar)
Floor chamber:	1.0 psi (0.07 bar)



2.1 Capacity

The person/load capacity is determined by the availability of proper seating on the kayak. Acceptable seating determines the number of passengers, not the overall load capacity.



Ultra-Lite™ Expedition Kayak Capacity Label

⚠ WARNING: Do not exceed the certified maximum capacities under any circumstances. Overloading will reduce freeboard and increase the likelihood of swamping, especially in heavy seas. Overloading causes handling to become sluggish, making it difficult to react quickly.

2.2 Features

Hull Design: Built-in Aluminum ribs define the bow and stern and improve tracking.

Durable: 3 Layers of material for extreme puncture resistance.

Easy to Set Up: Pre-assembled at the factory. Simply unfold, inflate, and attach the seats.

Comfortable: High support, adjustable padded seat provides comfort for hours of paddling.

Style: Looks and paddles similar to a rigid hard-shell kayak, with the portability of an inflatable.

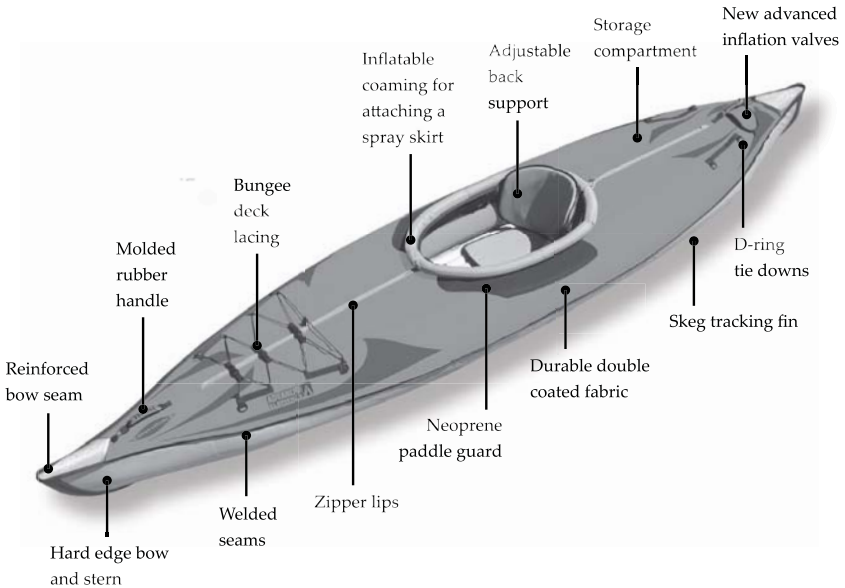

3. ASSEMBLY/INFLATING/DEFLATION INSTRUCTION

The Ultra-Lite™ Expedition Kayak has a rigid frame in the bow and stern that enhances its performance.

3.1 Assembly

The illustration below shows the general assembly of the kayak. Your kayak comes from the factory pre-assembled. The only assembly you should need to do is attach the adjustable seats. The only assembly you should need to do is attach the adjustable seat.

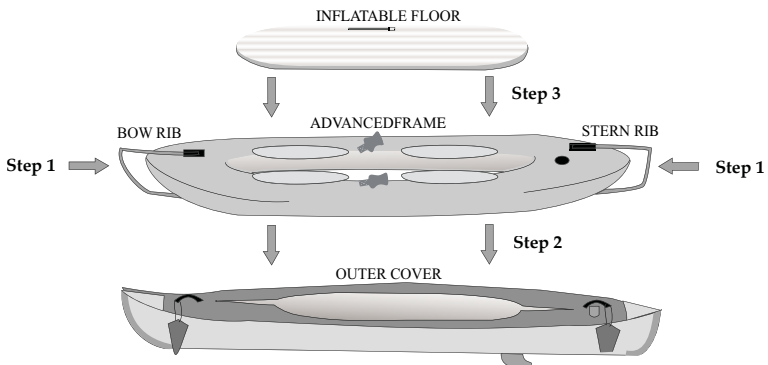

1. Your Ultra-Lite™ Expedition kayak comes from the factory pre-assembled however should you take it apart you will need to insert the aluminum Bow Rib and the Stern Rib into the webbing slots on the cover of the AdvancedFrame™ tube (while deflated).

2. Place the AdvancedFrame™ tube (with Ribs installed), into the Outer Skin, making sure that the air valve is upright and at the back of the boat and lined up with the opening on the outer cover. Chamber 1 and 2 are separate chambers but equalize in pressure because they are inside a fabric cover. Ideally you want to put half of the air in chamber 1 and half in chamber 2. This way if you suddenly lose pressure in one chamber you should have another chamber as a safety.
3. With the AdvancedFrame™ tube installed inside the outer skin place the inflatable floor inside the center of the Ultra-Lite™ expedition with twist valve up.
4. Attach the adjustable backrest to the AdvancedFrame™ side tubes by fastening buckles.

3.2 Understanding Your Valves

Advanced Elements Ultra-Lite™ Expedition kayak uses the following valves. It has the function and durability of other military type valves and is compatible with most standard pumps. The lock nut holds the valve in place with the cover for easy inflation. The following figures will have details on how to operate the valves.

NOTE:

Deflate - Push-in center stem and rotate clockwise to the locked position. Valve stem should be pushed-in.

Inflate - Push-in center stem and rotate counter-clockwise to the locked position. Valve stem should be pushed out.

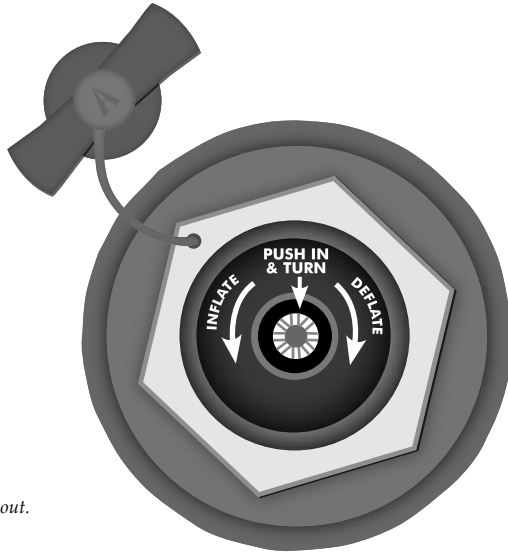

Figure 1. Inflate/Deflate Spring Valve

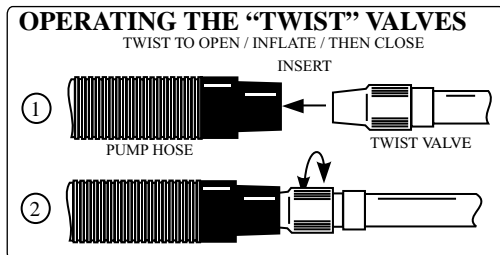

Figure 2. Inflate/Deflate Twist Valve

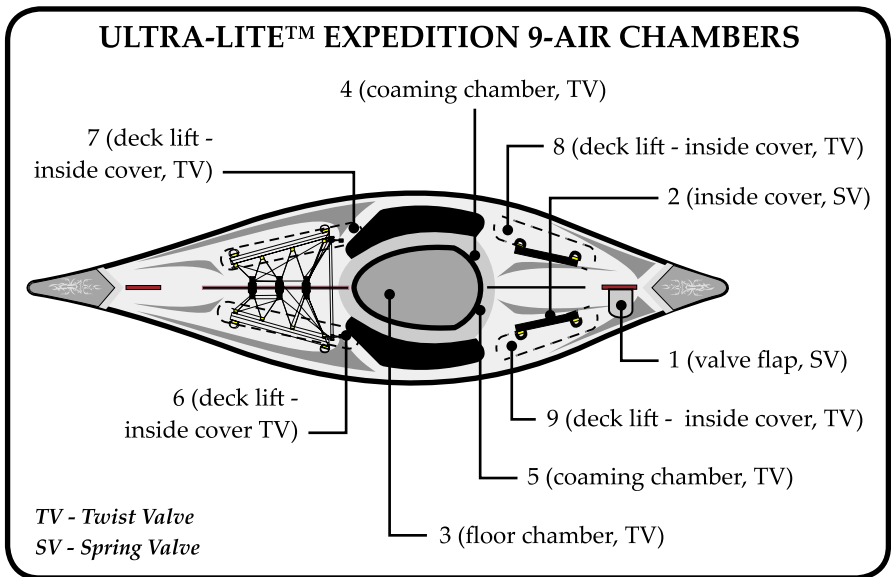

Diagram of Inflation Chambers

3.3 Inflating

IMPORTANT: Before inflating, check to be sure that the kayak is completely assembled. Inflate your kayak in the following order. **Failure to follow these instructions may cause damage to your kayak. Do not over inflate.**

1. Partially inflate chamber 1 until the kayak begins to fill out or appears to be half way inflated then close cap. Check to be sure the valve is in the inflate position (*See Figure 1*).
2. Inflate chamber 2 until the AdvancedFrame™ tube is firm to touch (2.0 psi **ONLY**).
3. Inflate chamber 3 “floor” (using appropriate fitting). Twist valve open to inflate and twist closed when complete (*See Figure 2*). Fill until firm. **Do Not Over-Inflate!** (1.0 psi **ONLY**)
4. Inflate Coaming chambers 4 & 5 until firm. Never over-inflate! (1.0 psi **ONLY**)
5. Inflate chamber 6 & 7/8 & 9 for desired deck lift. Never over-inflate! (1.0 psi **ONLY**)
6. Make sure all valves are closed tightly and properly.
7. Finally, Insert Plastic Bow and Stern forms into pocket on bow and stern (*Figure 3*).

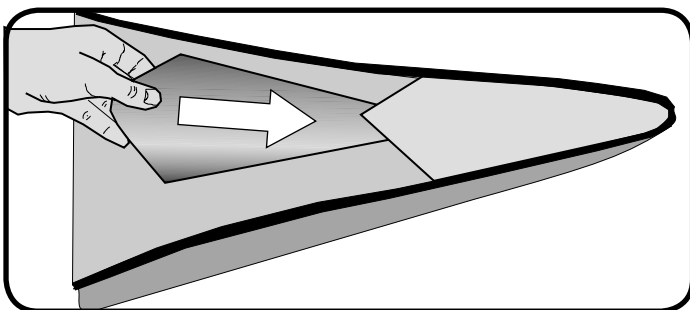

Figure 3. Plastic Bow and Stern Insert

INFLATION TIPS

Use either a bellows style foot pump or two-way hand pump to inflate to your kayak. Be sure that the fitting on the pump hose fits snug in the valve on the kayak. **NEVER USE COMPRESSORS, CO2 OR COMPRESSED AIR AS THEY MAY DAMAGE YOUR KAYAK.** The main chambers use high-end military style, plunger valves (Push in and twist to activate the spring-loaded check valve for inflating, or push-in and twist to lock open for deflating).

3.4 Over Inflation

⚠ CAUTION: Water temperature and weather will affect the air pressure of the kayak. In cold weather and water your kayak will lose some pressure. If this occurs, you may want to add a bit more air to the kayak to improve performance. In hot weather or prolonged sunlight, the air inside the kayak will expand. You must let some air out of the appropriate chambers to prevent the kayak from failing due to overpressure. You should avoid exposing your kayak to extreme temperatures (hot or cold).

3.5 Deflation

1. Remove the caps from chamber 1 & 2.
2. Push stems inward and rotate to deflate position (*See Figure 1*).
3. Open twist valves on chambers 3 through 9.
4. Once the chambers are deflated you can use your pump to vacuum out any additional air for improved folding. This requires a pump capable of deflating.

3.6 Folding

NOTICE: Reverse your pump to completely deflate all chambers.

1. Completely deflate all air chambers, thoroughly dry kayak and remove the seat. Reversing your pump to pump out all the remaining air will make folding easier.
2. Remove plastic Bow and Stern forms then lay kayak out flat.
3. Fold in half, down the center (right to left) (A).
4. Fold into 5 equal sections.
5. Place into duffel bag.

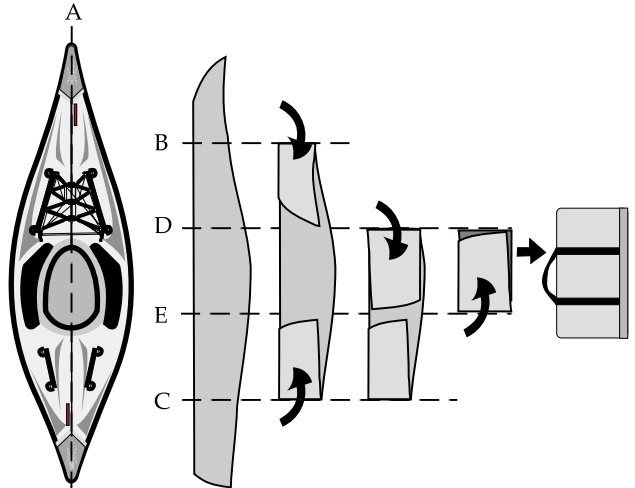

4. GUIDELINES FOR USAGE

Paddlesports can be very dangerous and physically demanding. The user of this product should understand that participation in paddlesports may involve serious injury or death. Observe the following safety standards whenever using this product. The user of this product acknowledges both an understanding and an assumption of the risk involved in paddlesports.

After you have inflated your kayak and before you put it in the water, inspect your equipment for obvious signs of wear or failure. Review local rules and regulations and read again the "CAUTION" statement.

Most areas have local laws and regulations about the use and equipment of small boats. Usually a phone call to the local authorities will provide you with the needed information. Some areas may require that you register and display a registration number on the front of your kayak. Once you have been issued a number, it is best to affix it to the kayak by printing it on the material with a permanent ink marker. If you are required to display a sticker or vinyl letters, an inflatable boat ID kit can be purchased at most marine stores.

Your kayak is designed to be paddled with a double bladed kayak paddle. Paddle with short and even strokes. Keep the blade close to the kayak and the paddle almost vertical. Pull with your lower hand and push with your upper hand. To reduce the amount of swaying at the front of the kayak, ease off on the force of your stroke. Paddling with a backward stroke can sometimes offer quick maneuverability.

ALWAYS practice safety and take the time to learn about the area where you are paddling. Get official information about the local tides and currents before paddling there. Be careful that you do not over estimate your strength, your endurance or your skill. Be careful never to underestimate weather conditions. Be aware of the dangers before you begin. Be aware of your skill level. Be sure you understand and accept the risk of these dangers. There are many paddling clubs all over the world. These can be a great source of information on places to paddle, people to paddle with and most importantly, continued safety practices.

5. PROPER CARE AND STORAGE

Your inflatable kayak is made of very durable materials. However, like anything else, proper use and care will increase the life of your kayak. Before storing your kayak, make sure it is both CLEAN and DRY. You may clean your kayak with a mild soap and water. **NEVER** use strong solvents to clean your kayak as they will destroy the material.

NEVER unzip the chamber cover when the kayak is inflated.

Be sure to rinse your kayak with fresh water after every use in salt water and allow it to dry thoroughly before storing. Use a dry towel to wipe up all moisture. It should be deflated and kept out of direct sunlight when stored. Avoid exposure to extreme temperatures (hot or cold). If your boat is exposed to freezing temperatures while storing, allow it to warm up before unfolding.

Do not store your kayak for an extended period of time while wet.

Follow these steps for removing excess water.

1. Unzip the 2 zippers that run down the center of the kayak.
2. Remove the gray fabric tube and cover, along with the inflatable floor, separating it from the outer cover. In order to completely separate these parts, it is necessary to unscrew the locking nut on the spring valve.
3. Use a sponge or towel and wipe up any excess water in the outer cover.
4. Wipe off the floor (top and bottom)
5. If there is sand or gravel in the kayak, you can hose out the cover and then wipe it down with a towel.
6. Most of the time you can just pull out the inflatable floor and wipe out the inside of the kayak absorbing most of the water, then pack it up.

6. REPAIRS

All kayaks come with a repair kit that includes glue and several patches. This should remain with the kayak in the event that you may need it. If service is required for your kayak, please call **866-262-9076** for assistance.

6.1 Repairing Small Punctures and Cuts

1. Cut a rounded patch at least $\frac{1}{4}$ " or $\frac{1}{2}$ " larger than the hole or cut.
2. Clean the area where the patch will be placed with water and/or mild soap.
3. Make sure all surfaces are dry.
4. In a well ventilated area, spread a thin layer of glue on both the patch and on the damaged area. Let it sit for three to five minutes or until tacky.

6.2 Repairing Pinholes

1. Inflate the PVC tube. Locate the pinhole by sponging soapy water over the tube until you see air bubbles. Mark the location of the pinhole.
2. Deflate the tube and dry the affected area. Apply a drop of glue to the pinhole
3. Allow glue to dry completely.
4. Do not inflate the kayak for at least twelve hours.

7. TROUBLESHOOTING

PROBLEM

SOLUTION

Does not hold air while inflating.

The spring valve uses a plunger system. The only time the plunger should be in the open position is when you are deflating. Make sure that the plunger is closed to inflate. Push the plunger in and rotate counter-clockwise.

The kayak is sagging or under inflated.

Be sure that the right pump is being used. You need a bellows foot pump or a double action hand pump. A 12-V electric does not supply enough pressure to fully inflate the kayak. The 12-V can be used to partially inflate the kayak but one of the other pumps is needed to top it off.

The kayak will not hold full pressure for more than a couple of hours.

Make sure that the plunger is in the closed position. It should only be open when deflating. If it is open, the only seal is the black rubber gasket inside the cap. Even then, a little air may still leak out.

Kayak still loses air.

If you have checked all the previous possible reasons for the kayak losing air, then there may be a pinhole or a puncture somewhere on the tube. Pull tube from outer covers. Inflate. If you cannot see or hear where a leak may be, take a clean rag with soapy water and begin rubbing the tube. If a hole is present, bubbles will continually form. Repair using repair kit. If it is a very small pinhole, a dab of the glue may be sufficient.

Tube is kinked or bent in.

The tube just needs to be adjusted. When kayak is fully deflated try adjusting the position of the tube inside of the outer shell. Then reinflate.

The fin is bent.

After inflating the kayak, turn upside down and leave out in sun for approximately ten minutes. Fin will conform to its original shape. Even if it is slightly bent, it will not affect the kayak performance.

The floor has formed a large bubble.

If two of the ridges in the floor have formed one large one, the I-beam has come apart. This is caused by over inflation. It cannot be repaired. It is important to take all over inflation warnings very seriously.

Water in the kayak.

There will almost always be a little water in the kayak. One reason is the water drips off of the paddle and into the kayak. Another is some will puddle up on the deck and leak through the zipper. Make sure that the deck lifts are fully inflated so a puddle does not form. You can also get a spray skirt from our accessories list from a dealer. This will help keep the inside of the kayak dry as well as you.

The kayak drifts to one side.

A kayak will always head in the direction of your last stroke. The longer the kayak the less this is usually noticed. If it is drifting in the opposite direction, the floor may not be aligned. Make sure that the floor is properly centered inside the kayak cover. If the floor is off-center it will cause unevenness in the kayak.

PADDLING NOTES:

It is always a good idea to keep notes of your paddling experiences. Your notes can serve as a reminder of what to look out for, as well as what gear to bring along, and what conditions are like.

DATE	TIME	LOCATION	NOTES

NOTES:

NOTES:

Declaration of Conformity

(according to ISO/IEC Guide 22 and EN 45014)

Manufacturer's Name: Advanced Elements, Inc.

Manufacturer's Address: P.O. Box 5128
Concord, CA 94524

declares, that the product:

Product Name: Ultra-Lite™ Expedition Kayak

Model Number (s): AE1012

to which this declaration relates, **meets the essential health and safety requirements** and is in conformity with the relevant EU Directives listed below:

General Product Safety Directive

using the relevant section of the following EU standards and other normative documents:

EN / UNI 6185-1 : 2006

ABYC H28-76

Date: January 1, 2006



Clay Haller, President

This product complies with European directives for recreational vessels as published by the International Organization for Standardization (ISO).

LIMITED WARRANTY

Advanced Elements, Inc. warrants this product to be free from defects in material or workmanship for a period of one year from the date of purchase. Products that prove to be defective under conditions of normal and proper use during the warranty period because of defective workmanship or faulty material will be replaced or repaired without charge. For warranty service, contact Advanced Elements, Inc.

Advanced Elements, Inc shall inspect all warranty claims and in the event of a defect, repair or replace the defective part or entire item, at its option. The purchaser must, before return of a defective product, obtain from Advanced Elements, Inc, a return authorization number and return center address. Please write or call as listed below. Once an authorization number is obtained, the purchaser must ship the product, POSTAGE PREPAID, to Advanced Elements, Inc for repair. Do not ship to P.O. Box address as it may be sent back.

This warranty does NOT cover:

Products used for rental, for hire or in professionally guided tours and other uses not considered normal recreational purposes; and punctures, cuts and abrasions sustained in normal use; and items involved in accidents; and items damaged in white water mishaps, and other unreasonable uses or improper storage.

Advanced Elements, Inc shall within (30) days from receipt of an authorized return from purchaser, perform its responsibilities in conformance with this warranty.

THERE ARE NO WARRANTIES WHICH EXTEND BEYOND THE DESCRIPTION OF THE FACE HEREOF. ADVANCED ELEMENTS SHALL NOT BE HELD LIABLE FOR INCIDENTAL AND CONSEQUENTIAL DAMAGES.

THIS WARRANTY IS INCLUSIVE IN LIEU OF ALL OTHER WARRANTIES.

This warranty gives you specific legal rights, and you may also have other rights that vary from state to state.

Advanced Elements, Inc.

P.O. Box 5128, Concord, CA 94524

Toll Free - 866-262-9076 - email info@advancedelements.com - www.advancedelements.com

(cut along line)

ADVANCED ELEMENTS WARRANTY REGISTRATION

(PLEASE TYPE OR PRINT CLEARLY)

Please complete and mail card to Advanced Elements within 10 days. It will register your product.

Mail to: Advanced Elements, Inc.
P.O. Box 5128, Concord, CA 94524
Attn: Warranty Department

Owner's Name _____

Address _____ Apt. _____

City _____ State _____ Zip _____

Model _____ HULL (12 characters) # _____

Purchase Date _____

Store Name _____

Store Address _____

City _____ State _____ Zip _____

Thank you for responding to the following.....

1. How did you first learn of this product?

Dealer Friend Magazine Radio TV Catalog Other

2. What most influenced your decision to purchase this product?

Price Features Style Quality Other

IMPORTANT!

**PLEASE READ THIS MANUAL CAREFULLY BEFORE PROCEEDING.
AFTER READING THIS MANUAL, SAVE THESE INSTRUCTIONS
FOR FUTURE REFERENCE.**

**If you would like a catalog of our latest products please
visit our website at
www.advancedelements.com
or call Toll Free 866-262-9076**

**PLEASE COMPLETE THE OTHER SIDE OF THIS
WARRANTY REGISTRATION CARD AND RETURN TO ADVANCED ELEMENTS, INC.**

PLACE
STAMP
HERE



P.O. Box 5128
Concord, CA 94524
1-866-262-9076
www.advancedelements.com
Email: info@advancedelements.com